

StepGuard™ Max Life Safety

SG-MAX-HB: LED lamps facing down

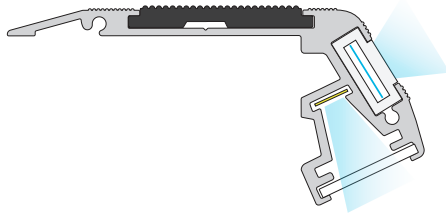

Designed for an immersive experience in mind with another level of safety, especially for public venues or government facilities. It is possible to swap the Light Tape® down light and go with a High Bright LED to illuminate each stair riser.

The MAX Design will help to eliminate the light cast forward with our novel aluminum internal light guide. You will not be able to see the light source while seated.

The illumination from the LEDs will more than meet any life safety illumination codes. The MAX Life Safety design is recommended for flat floors or low pile carpet venues..

Design Features:

- Arrives Plug & Play ready for installation, IP65 rated
- Illuminated by Light Tape® Electroluminescent lamp
- Aluminum profile length tolerance: +/- 3mm
- Extremely energy efficient: 1 /4 watt per meter
- Fully compliant - TUV IECEE IP65 certified
- Aluminum profile with non-slip insert on top
- Screws into step for quick installation.
- Mechanically fastened end caps, not glued

System and Parts

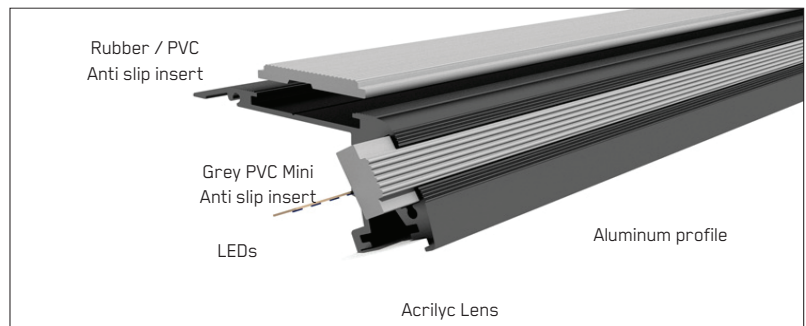

How to Order

- Part Number - SG-MAX-HB
- For a basic quote, we need the number of steps per cinema and average width per step to determine power layout. We also offer a service where we will go through architectural files to determine what is required for the installation.
- For final sign-off we will verify color of Light Tape®, on-site step widths and which side of step for electrical connection based on plan.

- Designed to exceed 0.2 foot candles for Life Safety Codes
- 4.8 watts per meter. 90% more than Light Tape EL Lamps.
- 200 milliamps of current per linear meter step.

Rapid Installation

- Always use Heat Shrink Tubing Thin Wall, 2:1 Shrink Ratio to seal connections between profile lead and your main wiring.
- To fix profile on surface, we recommend using 1/4 x 2 1/4 screw with nylon anchor every 10cms / 3.93 inches.

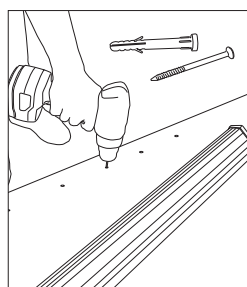
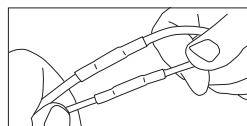

For step by step installation process, please refer to our installation manual guide.

SG-MAX-HB Dimensions

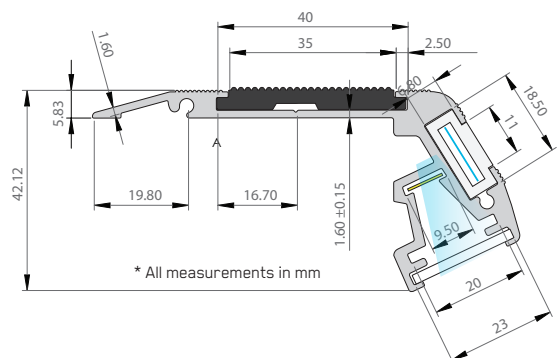

Color Options

Our base colors are Classic Natural Blue and Extreme Blue-Green. These colors appear white when off and colored when illuminated. We then add a filter to produce specific color options. All other colors will remain that color when not illuminated. Please check our website for updated and new colors.

Classic Series



A	B	Inches
6.35mm	19.05mm	0.25

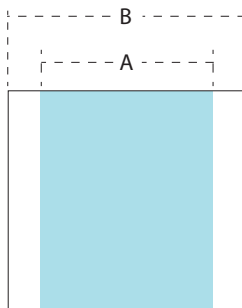

A= Illuminated width
B= Laminated width

Extreme Series

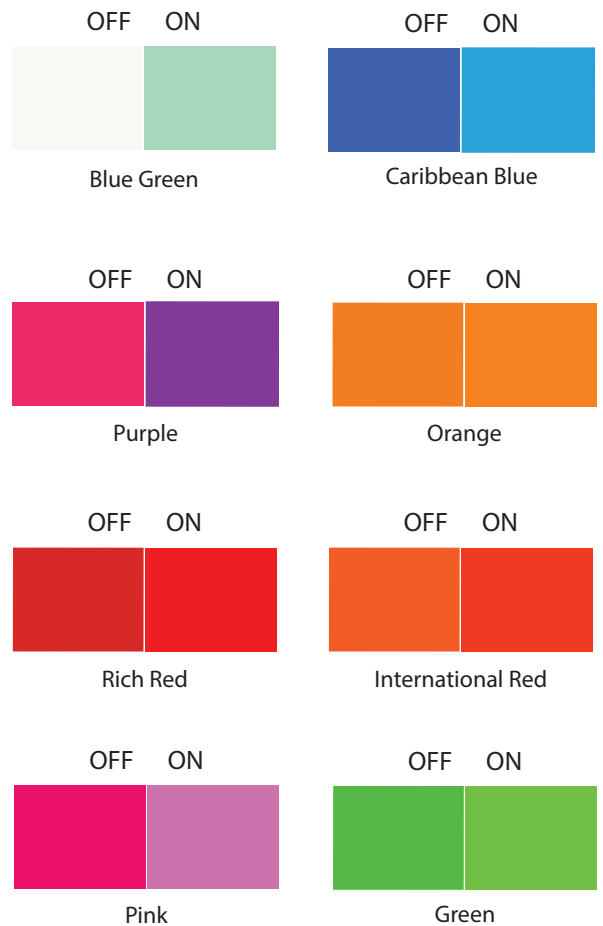

* The colors in this table are simulated and the final product may vary. If an exact color is required, we recommend seeing a physical sample. Custom colors and widths are available, but may be subject to minimum order quantities, set-up fees, and approval testing.

Digital Smart Driver™ Power Supply

Digital Smart Driver™ power supplies are specifically engineered to illuminate Light Tape®. Whether it is one segment or 80, it is possible to do it all with one Smart Driver™. There are a variety of models to choose from offering a variety of useful features. A factory representative will advise which model to use based on the total illuminated area, zones, and location.

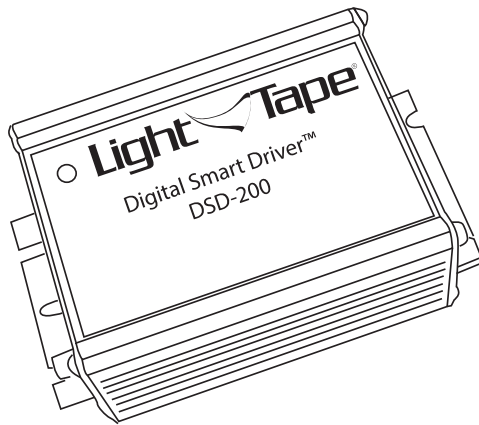

- Quiet
- Stylish compact design
- Rated input voltage 110 / 220 VAC
- Protection Class 1
- IP Degree 2x
- Worldwide voltage capacity
- Blink and Dimmer Switch
- Visual LED system status indicator
- Lightweight
- Short circuit and overload protection
- CE, UL y CSA compliant
- 0-10 dimming

Driver Ranges and Output

Driver Model	Range		Input		Output
	English System	Metric System	Ams	Watts	Max. Current, A
SD-8000	4000 - 8000 in ²	25,806 - 51,612 cm ²	3.50	420	3.8
BUS-DSD-4000	2000 - 4000 in ²	25,806 - 51,612 cm ²	3.50	420	3.8
DMX-DSD-4000	2000 - 4000 in ²	12,903 - 25,806 cm ²	1.5	145	2.1
DMX-DSD-2000	1000 - 2000 in ²	6,451 - 12,903 cm ²	1.0	110	1.2
DMX-DSD-1000	400 - 1000 in ²	2,580 - 6,451 cm ²	0.9	100	1.0
DMX-DSD-200	1 - 200 in ²	6,5 - 1,290 cm ²	0.5	12	0.15
DSD-200 D	1 - 200 in ²	6,5 - 1,290 cm ²	0.5	9	0.15
DSD-2000	1000 - 2000 in ²	6,451 - 12,903 cm ²	2.8	68	0.91
DSD-1000	400 - 1000 in ²	2,580 - 6,451 cm ²	0.9	97	0.32
DSD-400	200 - 400 in ²	1,290 - 2,580 cm ²	0.7	17	0.11
DSD-200	1 - 200 in ²	6,5 - 1,290 cm ²	0.5	9	0.15

*Max Vac is 320v at 750hz

Smart Driver™ Safety & Handling

It is important that you operate Light Tape® and Smart Driver Power Supplies within their parameters. Changes to parameters that result in over current will damage the Light Tape® lamp and power supplies.

- Always attach Light Tape® load before powering .
- 250 volts is mid-range and recommended set point.
- The external dimmer switch on Smart Driver™ controls the output voltage and frequency.
- Use a voltage meter to determine volts /hertz from Smart Driver™ to Light Tape®.
- Always set power supply output voltage per factory recommended setting.
Low: 200 volts | Medium: 250 volts | High: 300 volts
- We DO NOT recommend exceeding 300 volts. Contact us if the Smart Driver™ is operating outside of range.
- Red LED indicates the following :
 - a.Short Circuit Protection : Check wiring if light is on.
 - b.Overload Protection: Verify that lamp area is acceptable, or for possible damage to lamp.
- Always treat Light Tape® and Smart Driver™ with care and respect as one would with any device where electrical current is present
- Please store in appropriate NEMA enclosure for outdoor/ damp location.
- Please follow local electrical codes .

Digital Smart Driver™ Power Supply

Features

- StepGuard® is exclusively made for Light Tape®
- DMX Mode- 512 Supplies are fully DMX controllable, allowing for integration into complicated stage and light show.
- Blink Mode- Allows for on/off pulse control with fine turning knob.
- Brightness Control- luminosity adjustment to appropriately match installation environment.
- 0-10 Dimming- Optional function to remotely control Light Tape® brightness using standard 0-10v dimmers. Compatible with Lutron Dimmers.

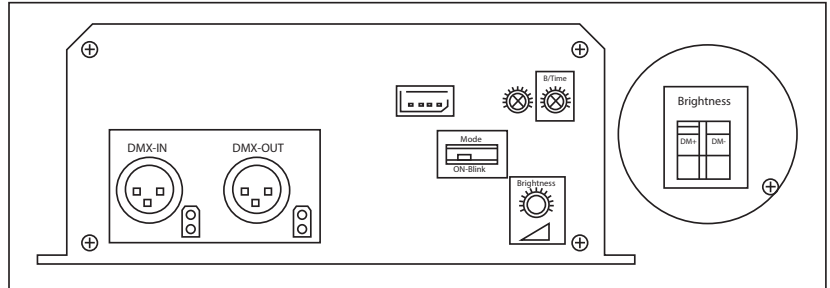

Driver Model	DMX	BLINK	BRIGHTNESS	0-10
SD-8000		X	X	
DSD 200 0-10 DIMMING			X	X
DSD 4000 DMX	X	X	X	X
DSD 1000 DMX	X	X	X	X
DSD 200 DMX	X	X	X	X
DSD 2000			X	X
DSD 1000			X	X
DSD 400			X	X
DSD 200			X	

Power Supply Dimensions

Driver Model	Length		Width		Height		Wheight
SD-8000	9 7/8 in	2.5 cm	4 3/4 in	12 cm	2 1/4 in	5.7 cm	4.15 lb
BUS-DSD 4000	8 3/4 in	22 cm	6 1/4 in	15.8 cm	3 in	7.6 cm	5.15 lb
DMX-DSD 4000	8 6/8 in	22 cm	7 1/4 in	18.5 cm	2 3/4 in	7 cm	4.9 lb
DMX-DSD 2000	8 6/8 in	22 cm	7 1/4 in	18.5 cm	2 3/4 in	7 cm	4.9 lb
DMX-DSD 1000	7 3/4 in	19.5 cm	3 3/8 in	8.5 cm	2 in	5 cm	1.85 lb
DSD 200 DMX	6 in	15.5 cm	2 5/8 in	6.75 cm	1.5 in	4 cm	0.85 lb
DSD 200 D	6 in	15.5 cm	2 5/8 in	6.75 cm	1.5 in	4 cm	0.8 lb
DSD 2000	8 3/8 in	22.5 cm	3 3/8 in	8.5 cm	2 in	5 cm	2.05 lb
DSD 1000	7 3/4 in	19.5 cm	3 3/8 in	8.5 cm	2 in	5 cm	1.85 lb
DSD 400	6 5/8 in	16.5 cm	2 5/8 in	6.75 cm	1.5 in	4 cm	1.05 lb
DSD 200	4 7/16 in	11.3 cm	2 3/4 in	7.0 cm	1 5/8 in	4.1 cm	0.70 lb

BLAZE™ 100/200/300 LED Tape Light

Performance and value for everyday projects. Our most popular tape light, available in a wide range of color temperatures and outputs.

Date _____

Project Notes _____

FEATURES

- 90+ CRI
- 12V and 24V platforms
- Can comply with Title 24 Part 6 JA8 requirements
- Heavy-duty copper PCB for long lasting performance
- 100/200/300 lumen outputs
- Precision color rendering with 90+ R9 value
- 7 Year limited warranty

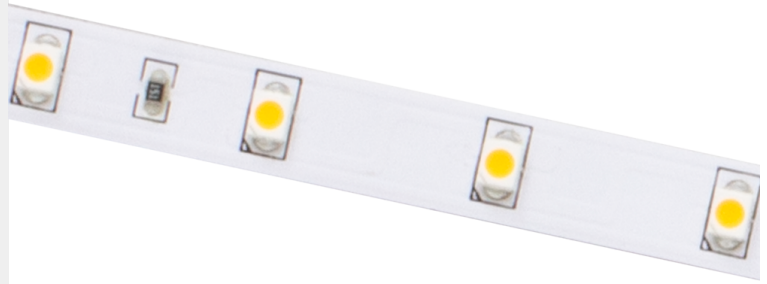

ORDERING CODES

Order spools, and components for field assembly

OPTIONAL ORDERING CODES

Mounting, drivers, and assembly preference

Diode LED	Voltage	Model	CCT		Length	Channels			Finish	Mounting			Drivers	Delivery
DI														
	12V	BLBSC1	20 (2000K)	42 (4200K)	016 (16.4 foot spool)	SL (Slim)	SQ (Square)	MI1 (1-inch Mud-In)	AL (Aluminum)	3M (3M Adhesive)	VC (Vertical Clip)	ELV (Electronic)	O/O (On / Off)	FIELD HYBRID FACTORY *See Delivery Options
	24V	BLBSC2	27 (2700K)	50 (5000K)	100 (100 foot spool)	CA (Canal)	45 (45°)	REC (Recessed)	WH (White)	MC (Mounting Clip)	HNG (Hanging Hardware)	O10 (0-10V)	LUT (Lutron)	
		BLBSC3	30 (3000K)	63 (6300K)	400 (400 foot spool)	S1 (S1)	45DCO (45° Deco)	SLR (Slim Recessed)	BL (Black)	UC (U-Clip)	RC (Rotating Clip)	MAG (Magnetic)	PoE (Power over Ethernet)	
				35 (3500K)			RC10 (10mm Round)	90 (90° Sideview)	GZR (Grazer)				SWX (Switchex)	
						SQ10 (10mm Square)	MI1 (1-inch Mud-In)	WF (Waveform)						

Model	12V-BLBSC1	12V-BLBSC2	24V-BLBSC1	24V-BLBSC2	24V-BLBSC3
Voltage	12V	12V	24V	24V	24V
Wattage	1.46 W/ft.	2.93 W/ft.	1.46 W/ft.	2.93 W/ft.	4.5 W/ft.
Lumens	2000K	N/A	N/A	N/A	290/ft.
	2700K	117/ft.	212/ft.	113/ft.	233/ft.
	3000K	121/ft.	221/ft.	117/ft.	237/ft.
	3500K	117/ft.	236/ft.	126/ft.	249/ft.
	4200K	131/ft.	252/ft.	133/ft.	265/ft.
	5000K	130/ft.	256/ft.	132/ft.	261/ft.
	6300K	121/ft.	272/ft.	132/ft.	276/ft.
Cut Points	2 in.	1 in.	4 in.	2 in.	2 in.
Max Run	27 ft.	20 ft.	55 ft.	40 ft.	22 ft.
Max Run (Class 2)	41 ft.	20 ft.	65 ft.	32 ft.	21 ft.
LED Chips	18/ft.	36/ft.	18/ft.	36/ft.	36/ft.
CRI	90+ CRI	90+ CRI	90+ CRI	90+ CRI	90+ CRI
Dimensions	0.31 x 0.1 in (W x H)	0.31 x 0.1 in (W x H)	0.31 x 0.1 in (W x H)	0.31 x 0.1 in (W x H)	0.31 x 0.1 in (W x H)
Environment	Indoor / Damp Location (IP20)	Indoor / Damp Location (IP20)	Indoor / Damp Location (IP20)	Indoor / Damp Location (IP20)	Indoor / Damp Location (IP20)
Ambient Temperature	-4 ~ 122°F (-20 ~ 50°C)	-4 ~ 122°F (-20 ~ 50°C)	-4 ~ 122°F (-20 ~ 50°C)	-4 ~ 122°F (-20 ~ 50°C)	-4 ~ 122°F (-20 ~ 50°C)
Operating Temperature	-4 ~ 176°F (-20 ~ 80°C)	-4 ~ 176°F (-20 ~ 80°C)	-4 ~ 176°F (-20 ~ 80°C)	-4 ~ 176°F (-20 ~ 80°C)	-4 ~ 176°F (-20 ~ 80°C)
Certification	UL Listed 2108	UL Listed 2108	UL Listed 2108	UL Listed 2108	UL Listed 2108
Warranty	7 Year	7 Year	7 Year	7 Year	7 Year

BLAZE™ 100/200/300 LED Tape Light

Performance and value for everyday projects. Our most popular tape light, available in a wide range of color temperatures and outputs.

Date _____

Project Notes _____

RECOMMENDED DRIVERS

SKU	WATTAGE	LENGTH	WIDTH	HEIGHT
OMNIDRIVE® X Compact electronic dimmable (ELV) driver for everyday projects.				
DI-ODX-24V30W-J	30W	6.5 in.	3.7 in.	1.36 in.
DI-ODX-24V60W-J	60W	7.4 in.	3.7 in.	1.36 in.
DI-ODX-24V96W-J	96W	8.66 in.	3.7 in.	1.36 in.
DI-ODX-24V120W-J	120W	8.66 in.	3.7 in.	1.36 in.
DI-ODX-24V200W-J	200W	10.24 in.	4.92 in.	1.95 in.
SWITCHEX® Driver and Dimmer Switch LED driver and dimmer switch combined in a single gang box.				
DI-24V-SE-60W	60W	1.4 in.	2.1 in.	4.1 in.
DI-24V-SE-100W	100W	1.4 in.	2.1 in.	4.1 in.
VLM Series Constant Voltage LED Drivers Compact constant-voltage LED driver				
VLM60W-24-LPM	60W	8.19 in.	2.94 in.	1.31 in.
VLM100W-24-LPM	100W	8.19 in.	2.94 in.	1.31 in.
Lutron® Hi-lume™ 1% Dimmable LED Drivers				
DI-DM-24V40W-L3D	40W	4.89 in.	4 in.	2.62 in.
DI-DM-24V40W-LTE	40W	4.89 in.	4 in.	2.62 in.
Lutron® Hi-lume Premier 0.1% LED driver				
DI-DM-24V96W-L3D	96W	5.5 in.	2.2 in.	10.5 in.
PoE 24V constant voltage platform, ready for Power over Ethernet (Inquire)				

RECOMMENDED CHANNELS

NAME	SKU	DIFFUSION	
Slim (SL) 48", 72", 96" Aluminum, White, Black	DI-CPCHA-SL	dotless	
Canal (CA) 48", 72", 96" Aluminum, White, Black	DI-CPCHB-CAN	dotless	
S1 (S1) 48", 72", 96" Aluminum	DI-CPCHB-S1	dotless	
10mm Round (RC10) 48", 72", 96" Aluminum	DI-CPCHB-RC10	dotless	
10mm Square (SQ10) 48", 72", 96" Aluminum	DI-CPCHB-SQC10	dotless	
Square (SQ) 48", 72", 96" Aluminum, White, Black	DI-CPCHA-SQ	dotless	
45° (45) 48", 72", 96" Aluminum, White, Black	DI-CPCHA-45	dotless	
45° Deco (45DCO) 48", 72", 96" Aluminum	DI-CPCHB-45DCO	dotless	
90° Sideview (90) 48", 72", 96" Aluminum	DI-CPCHB-90SD	dotless	
Rod (ROD) 48", 72", 96" Aluminum	DI-CPCHB-RDCL	dotless	
1-inch Mud-In (M1) 48", 72", 96" Aluminum	DI-CPCHB-MUD1	dotless	
Recessed (REC) 48", 72", 96" Aluminum	DI-CPCHB-REC	dotless	
Slim Recessed (SLR) 48", 96" Aluminum	DI-CPCHA-SLR	dotless	
Grazer (GZR) 48", 72", 96" Aluminum	DI-CPCHB-GRZRNB	dotless	
Waveform (WF) 48", 72" Aluminum	DI-CPCHB-WF	dotless	



BLAZE™ 100/200/300 LED Tape Light

Performance and value for everyday projects.
Our most popular tape light, available in a wide range of color temperatures and outputs.

Date _____

Project Notes _____

MECHANICAL DIAGRAMS

12V-BLBSC1

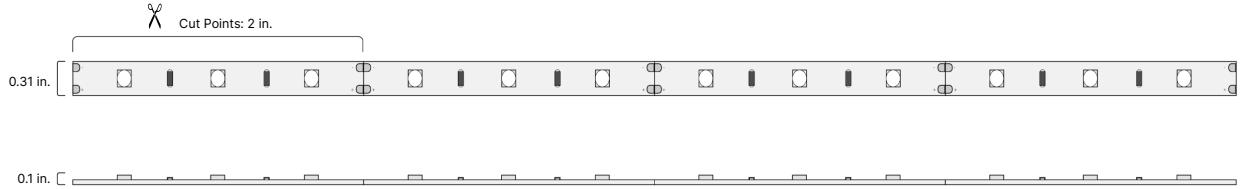

12V-BLBSC2

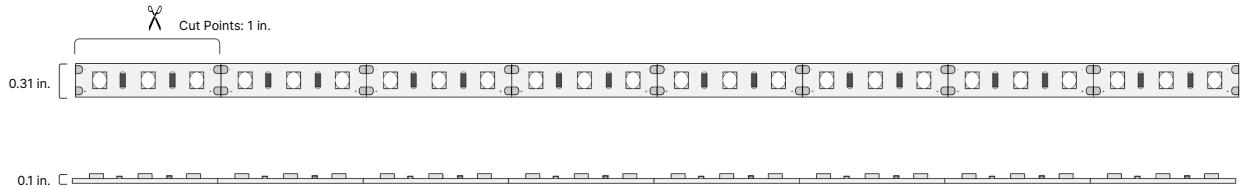

24V-BLBSC1

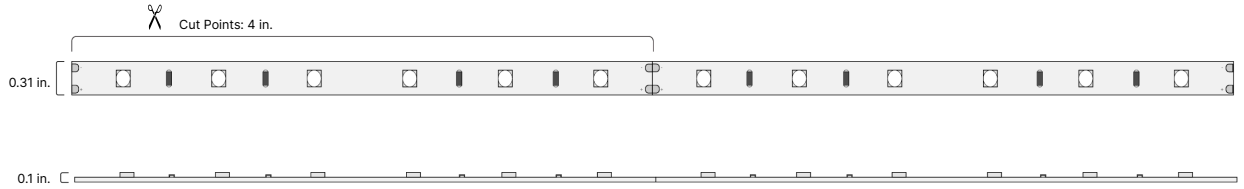

24V-BLBSC2

24V-BLBSC3

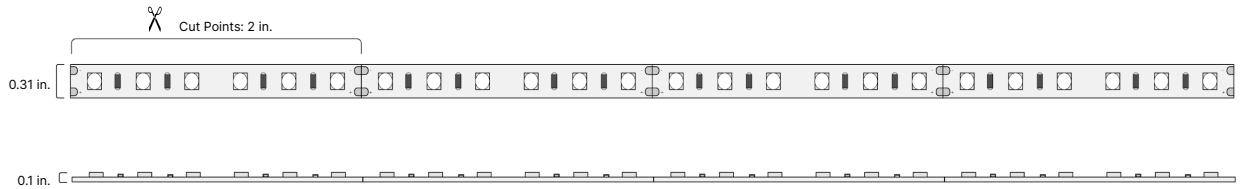

CONNECTIONS

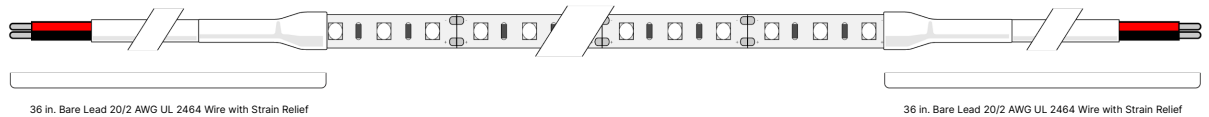

BLAZE™ 100/200/300 LED Tape Light

Performance and value for everyday projects.
Our most popular tape light, available in a wide range of color temperatures and outputs.

Date _____

Project Notes _____

TERMINAL BLOCK CONNECTORS

DI-TB8-CONN-TTT (Tape-to-Tape)

8mm Tape-to-Tape Connector

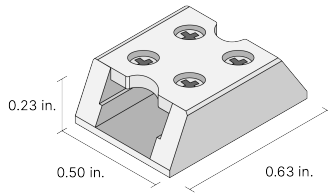

DI-TB8-CONN-TTW (Tape-to-Wire)

8mm Tape-to-Wire Connector

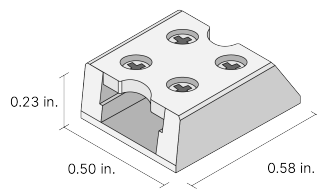

DI-TB8-6JPR (6 in.) DI-TB8-60JPR (60 in.)

Jumper Cable (Tape-to-Tape)

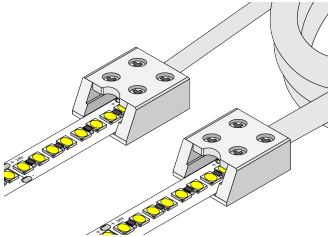

DI-TB8-60SPL (60 in.) (Tape-to-Wire)

Splice Wire (Tape-to-Wire)

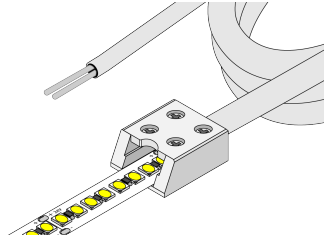

DI-TB8-90-TTT (Tape-to-Tape)

8mm 90° Tape-to-Tape Connector

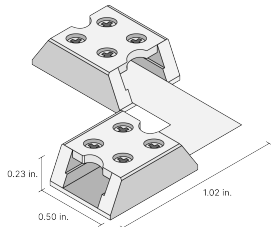

DELIVERY OPTIONS

- **Field Assembly**

Stock items for in-field assembly. Fastest order fulfillment.

- **Factory + Field**

Finished lengths of light with leads. Channels either bulk or factory finished. Some field assembly required.

- **Factory Assembly**

Fastest installation: fixtures fully assembled in the factory.

- Lumen value measured in accordance to IES LM-80-08. LED chips have a luminous flux range with a tolerance of +/- 5%.
- Each maximum run requires a dedicated power feed from the driver. Do not extend beyond the recommended maximum run length. Max run may exceed Class 2 limit. Actual wattage may differ from calculated wattage due to voltage drop across run.
- Do not install product in an environment outside the listed ambient temperature. Exceeding the maximum ambient temperature may damage LED chips, reduce the total lamp life, lumen output, and/or adversely impact color consistency.
- Actual efficacy value is dependent to specified LED driver (power supply). An estimated efficacy value can be calculated as follows: Lumen value divided by average power consumption per foot.
- Operating temperature is measured according to the minimum and maximum ambient temperature environment.

BLAZE™ 100/200/300 LED Tape Light

Performance and value for everyday projects.
Our most popular tape light, available in a wide range of color temperatures and outputs.

Date _____

Project Notes _____

CERTIFICATIONS

Safety

- UL Listed 2108 Low Voltage Lighting System / Low Voltage Luminaire. UL 1598 / CSA 250.0-08, UL 8750. UL 879 / CAN/CSA-C22.2 no. 207-M89. Certified for United States and Canada. File # E469769.
- UL Listed Field Cuttable.
- UL Recognized Component - Sign Accessories. Available in UL Sign Components Manual (SAM Manual). File # E469770.
- CE & EMC Compliant: Verification No. GZEM141200683705V
- Approved for storage areas of clothes closets per NEC 410.16.A.3 and 410.16.C.5

Environmental

- RoHS Compliant: Verification No. CANEC1610091501

Performance

- Can be used to comply with TITLE 24 Part 6 High efficacy LED requirements - JA8-2016-E
- LED chip data measured in accordance to IES LM-80-08.
- Photometric & Colorimetry data measured in accordance to IES LM-79-08, in Elemental LED's Innovation Lab.

Safety / Warnings / Disclosures

1. Install in accordance with national and local electrical code regulations.
2. This product is intended to be installed and serviced by a qualified, licensed electrician.
3. Only use copper wiring. Use wires rated for at least 176°F (80°C) and certified for use with external connection of electrical equipment.
4. Each maximum run requires a dedicated power feed from the driver. Do not extend beyond the recommended maximum run length.
5. Tape light, attached wire leads, and additional extension cables, connectors, etc., are not rated for in-wall installation unless otherwise noted. Tape light and attached wire leads are field-cuttable.
6. Ensure applicable wire is installed between driver, fixture, and any controls in-between. When choosing wire, factor in voltage drop, amperage rating, and type (in-wall rated, wet location rated, etc.). Inadequate wire installation could overheat wires, and cause fire.
7. Do not install in environment where LED chips are exposed to direct sunlight as damage to the phosphor will occur.
8. Do not install in environment where excessive heat may exist (ex. close proximity to fireplace, etc.) See Ambient Temperature ratings
9. Do not install indoor LED tape light products in outdoor / wet location environments. Only wet location tape light models are rated for outdoor / wet locations.
10. Do not modify product beyond instructions or warranty will be void.
11. Tape light must be handled with care. Excessive handling, bending, and pressure may damage the product, voiding the warranty.
12. Actual color may vary from what is pictured on this sheet and other print materials due to the limitations of photographic processes.
13. We reserve the right to modify and improve the design of our fixtures without prior notice. We cannot guarantee to match existing installed fixtures for subsequent orders or replacements in regards to product appearance, CCT, or lumen output.

WARRANTY

Limited Warranty

- 7 Years

This warranty does not include the additional accessories referenced in this specification sheet. Complete warranty details for fixtures and additional accessories are available at www.diodeled.com/limited-warranty/ within the Policies section. For warranty related questions please contact product support.

Consumer's Acknowledgment

Elemental LED, Inc. stands behind its products when they are used properly and according to our specifications. By purchasing our products, the purchaser agrees and acknowledges that lighting design, configuration and installation is a complex process, wherein seemingly minor factors or changes in layout and infield adjustments can have a significant impact on an entire system. Choosing the correct components is essential. Elemental LED is able to work with the original purchaser to make an appropriate product selection to the extent of the limited information that the customer can provide, but it is virtually impossible for Elemental LED to design a system that foresees every unknown factor. For this reason, this Warranty does not cover problems caused by improper design, configuration or installation issues. Any statement from a Elemental LED employee or agent regarding a customer's bill of goods and/or purchase order is NOT an acknowledgment that the products purchased are designed and configured correctly. The purchase agrees and acknowledges that it is the customer's responsibility to adhere strictly to all information contained in the Product Specification Sheets.

There is often more than one way to design, configure and layout an LED lighting application properly to achieve the same lighting effect. Elemental LED strongly recommends that licensed professionals be used in the design and installation of lighting systems that include Elemental LED products. The specifications include important information that a designer and installer should carefully review and strictly follow. Qualified designers and certified and/or licensed installers, with access to the final installation environment, customer goals, and Elemental LED product specifications can make the requisite decisions appropriate for a successful finished lighting application.

LM-79 Test Report

Relevant Standards

IES LM-79-2008
IES TM-30-2015
CIE 13.3-1995

Product SKU

BLAZE™ 100 LED Tape Light - DI-12V-BLBSC1-30-***

Test Conditions

Test Temperature: 26.5 °C
Luminaire Sample Length: 12 in.
Power Supply: Agilent E3634A DC Power Supply
Voltage: 12 VDC
Current: 0.114 A
Power Consumption: 1.368 W

Test Date

7/3/2018

Prepared By

Rachel Backlund

Rachel Backlund

Approved By

Olivia M. Tanguileg

Olivia Tanguileg, Electrical Engineer

The results contained in this report pertain only to the tested sample.
Photometric & Colorimetry data measured in accordance to IES LM-79-2008 standards, at the Elemental LED, Inc. Innovation Lab.

Integrating Sphere Test

SUMMARY OF RESULTS

Metric	Test	Reference	Notes	Metric	Test	Reference	Notes
R_f	91	100	IES TM-30-15 Fidelity Index	CCT	3032	3031	Correlated Color Temperature
R_g	99	100	IES TM-30-15 Gamut Index	D_{uv}	0.0015	0.0000	Distance from the blackbody locus
R_a (CRI)	92	100	CIE Test Color Method General Index	x	0.4369	0.4347	CIE 1931 chromaticity coordinate
R_9	64	100	CIE Test Color Method Sample Nine Score	y	0.4079	0.4033	CIE 1931 chromaticity coordinate
LER	287	164	Luminous Efficacy of Radiation	u	0.2489	0.2495	CIE 1960 chromaticity coordinate
Lumens	116	1852	Luminous Flux	v	0.3486	0.3472	CIE 1960 chromaticity coordinate
$R_{f,skin}$	95	100	Average of CES15 and CES18 (skin)	u'	0.2489	0.2495	CIE 1976 chromaticity coordinate
				v'	0.5229	0.5207	CIE 1976 chromaticity coordinate

COLOR RENDERING INDEX

R 1	R 2	R 3	R 4	R 5	R 6	R 7	R 8	R 9	R 10	R 11	R 12	R 13	R 14
92.1	94.3	95.0	92.7	91.1	92.1	94.5	85.1	63.9	85.4	92.4	76.4	92.4	96.4

SOURCE PROPERTIES

SOURCE CHROMATICITY COMPARISON

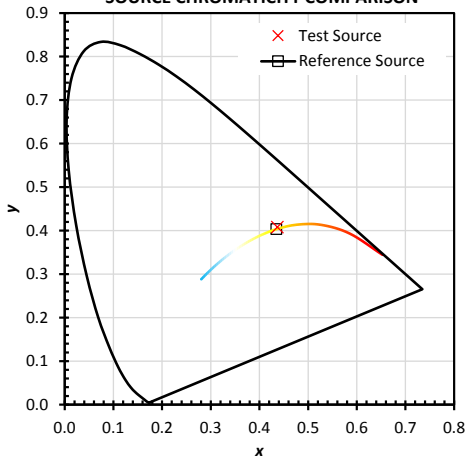

This chart plots the chromaticity of the test and reference sources in the CIE 1931 chromaticity

SPECTRAL POWER DISTRIBUTION COMPARISON

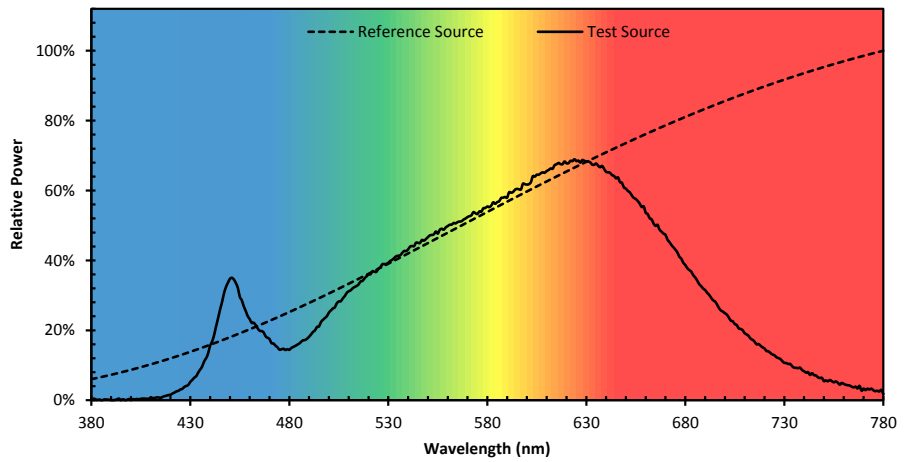

This chart displays the spectral power distributions for the test and reference source. Each SPD has been normalized so that the maximum values is 100%.

GENERAL COLOR RENDITION

CES CHROMATICITY COMPARISON

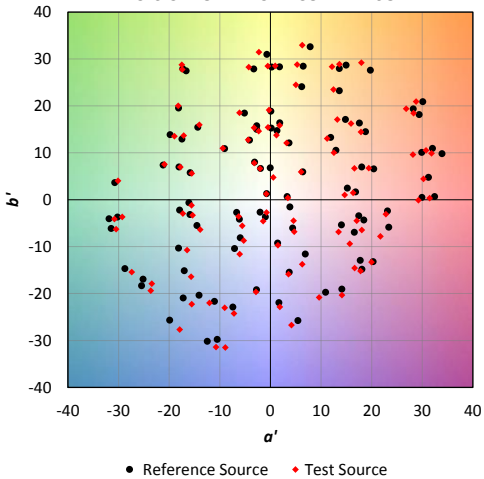

This plot shows the shift in chromaticity for each individual CES.

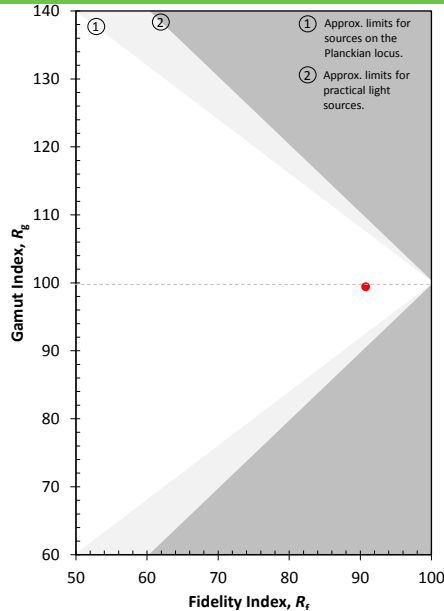

This plot shows the R_f and R_g values relative to possible values.

COLOR VECTOR GRAPHIC

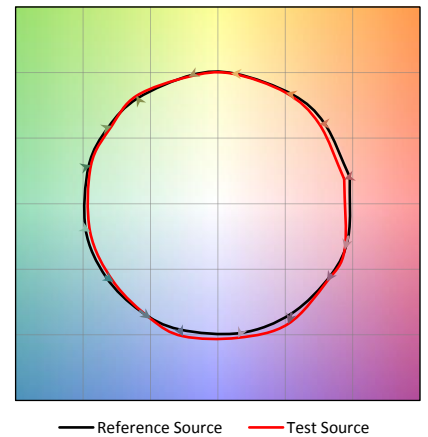

This plot shows the average chromaticity shift for the samples within each of 16 hue bins. The values are normalized so that the reference is a circle.

COLOR SAMPLE COMPARISON (APPROXIMATION)

CES 1 Type C	CES 2 Type C	CES 3 Type A	CES 4 Type A	CES 5 Type D	CES 6 Type C	CES 7 Type E	CES 8 Type D
CES 9 Type F	CES 10 Type G	CES 11 Type C	CES 12 Type A	CES 13 Type F	CES 14 Type E	CES 15 Type B	CES 16 Type C
CES 17 Type C	CES 18 Type B	CES 19 Type E	CES 20 Type F	CES 21 Type D	CES 22 Type D	CES 23 Type G	CES 24 Type E
CES 25 Type A	CES 26 Type C	CES 27 Type A	CES 28 Type G	CES 29 Type C	CES 30 Type A	CES 31 Type D	CES 32 Type C
CES 33 Type D	CES 34 Type G	CES 35 Type G	CES 36 Type A	CES 37 Type A	CES 38 Type A	CES 39 Type F	CES 40 Type F
CES 41 Type C	CES 42 Type F	CES 43 Type C	CES 44 Type F	CES 45 Type G	CES 46 Type E	CES 47 Type C	CES 48 Type D
CES 49 Type D	CES 50 Type F	CES 51 Type F	CES 52 Type F	CES 53 Type E	CES 54 Type F	CES 55 Type G	CES 56 Type G
CES 57 Type C	CES 58 Type D	CES 59 Type E	CES 60 Type G	CES 61 Type F	CES 62 Type C	CES 63 Type F	CES 64 Type E
CES 65 Type F	CES 66 Type E	CES 67 Type E	CES 68 Type F	CES 69 Type F	CES 70 Type F	CES 71 Type F	CES 72 Type F
CES 73 Type F	CES 74 Type C	CES 75 Type F	CES 76 Type F	CES 77 Type A	CES 78 Type F	CES 79 Type C	CES 80 Type G
CES 81 Type A	CES 82 Type C	CES 83 Type C	CES 84 Type F	CES 85 Type A	CES 86 Type C	CES 87 Type F	CES 88 Type F
CES 89 Type A	CES 90 Type E	CES 91 Type A	CES 92 Type A	CES 93 Type D	CES 94 Type C	CES 95 Type A	CES 96 Type A
CES 97 Type F	CES 98 Type A	CES 99 Type E					

NOTE: CES stands for "Color Evaluation Sample", these 99 samples are used in place of the 16 R values. The colors shown are approximate and depend on proper monitor calibration. Some colors may be outside of the gamut of the monitor, and will not be displayed accurately. For each sample, the color on the left represents the reference source, and the color on the right represents the test source.

Sample Type:

- A - Nature
- B - Skin
- C - Textiles
- D - Paints
- E - Plastic



Elemental

Competitor



COLOR RENDITION BY HUE

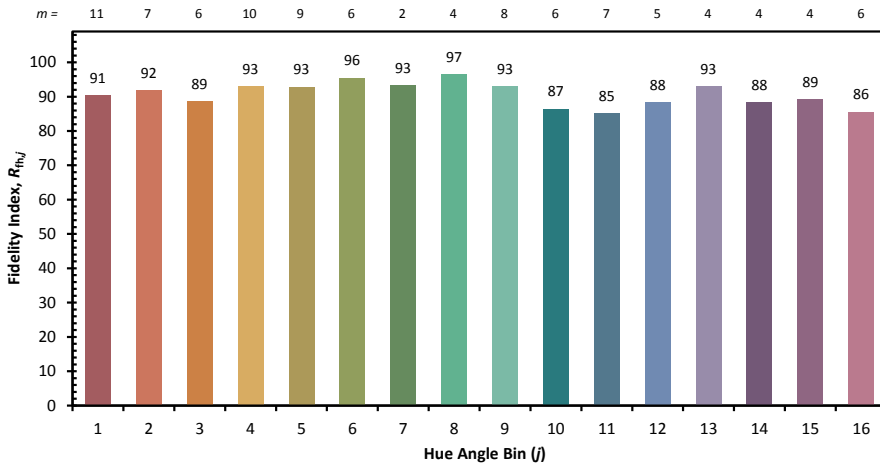

j	Hue Angle
1	0.0°-22.5°
2	22.5°-45.0°
3	45.0°-67.5°
4	67.5°-90.0°
5	90.0°-112.5°
6	112.5°-135.0°
7	135.0°-157.5°
8	157.5°-180.0°
9	180.0°-202.5°
10	202.5°-225.0°
11	225.0°-247.5°
12	247.5°-270.0°
13	270.0°-292.5°
14	292.5°-315.0°
15	315.0°-337.5°
16	337.5°-360.0°

This chart displays the average Fidelity Index for all samples within the hue bin. The number of samples per bin, which can vary based on the CCT used for the calculation, is shown at the top. The color of the bar is based on the average chromaticity under the 5000 K reference illuminant; the colors may not display accurately depending on the calibration of the monitor, and should be used for orientation only.

m = Samples per Angle Bin

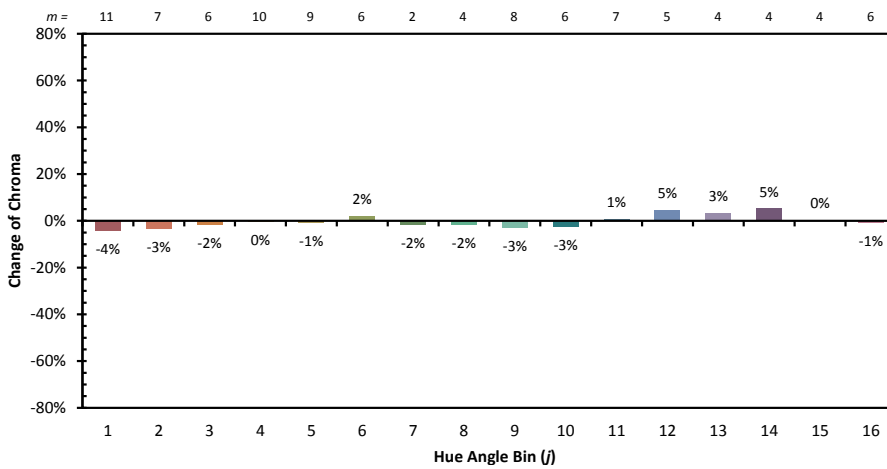

This chart displays the change in chroma for the average sample within each hue bin. The number of samples per bin, which can vary based on the CCT used for the calculation, is shown at the top. The color of the bar is based on the average chromaticity under the 5000 K reference illuminant; the colors may not display accurately depending on the calibration of the monitor, and should be used for orientation only.

COLOR FIDELITY BY SAMPLE

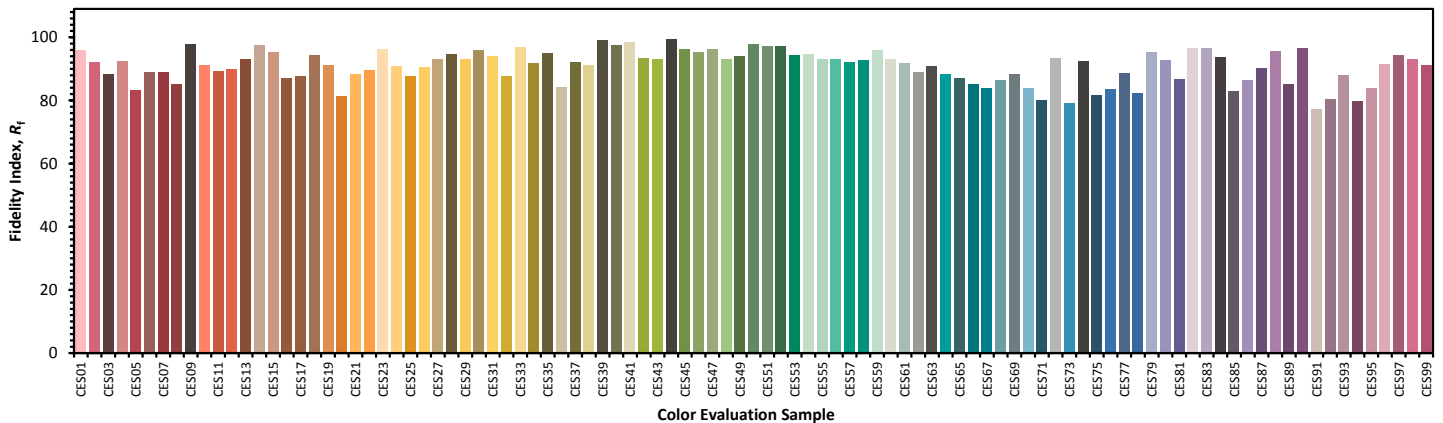

This chart displays the Fidelity Index for each of the 99 CES. The CES are arranged by their hue angle under the 5000 K reference source, which was also used to determine the color of each bar. The colors are approximate and depend on proper monitor calibration. Some colors may be outside of the gamut of the monitor, and will not be displayed accurately.

Goniophotometer Test

SUMMARY OF RESULTS

Luminaire: BLAZE™ 100 LED Tape Light
 SKU: DI-12V-BLBC1-30-***
 Luminous Flux: 119 Lumens
 Power Consumption: 1.368 Watts
 Efficacy: 87.0 Lumens/Watt
 Spacing Criterion (0-180): 1.28
 Spacing Criterion (90-270): 1.26

Graphs below are for reference, full IES files are available via request

DISTRIBUTION CHARTS AND TABLES

Zonal Lumen Data

Zone	Lumens	%Luminaire
0-20	15.27	12.80
0-30	32.45	27.20
0-40	53.24	44.70
0-60	94.38	79.20
0-80	117.09	98.30
0-90	119.14	100.00
20-40	37.97	31.90
20-50	59.60	50.00
40-70	55.82	46.90
60-80	22.71	19.10
70-80	8.03	6.70
80-90	2.04	1.70
90-180	0.00	0.00
0-180	119.14	100.00

Polar Candela Distribution

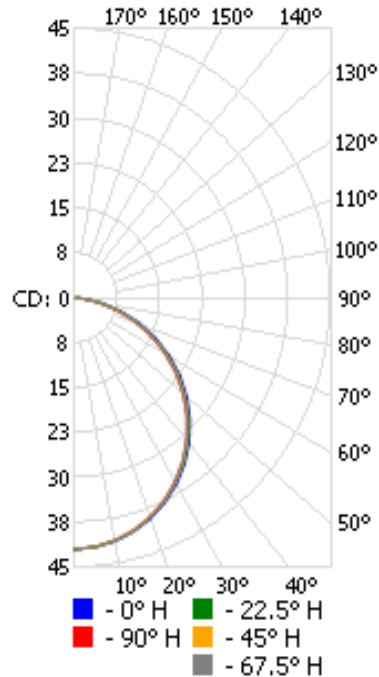

Illuminance at a Distance

	Center Beam fc		Beam Width	
1.5ft	18.6 fc	4.6 ft	4.4 ft	
3.0ft	4.65 fc	9.2 ft	8.9 ft	
4.5ft	2.07 fc	13.8 ft	13.3 ft	
6.0ft	1.16 fc	18.4 ft	17.8 ft	
7.5ft	0.74 fc	23.0 ft	22.2 ft	
9.0ft	0.52 fc	27.7 ft	26.7 ft	

■ Vert. Spread: 113.9°
■ Horiz. Spread: 112.0°

Export Packing

Features

- Sturdy Palletized Wooden Crate made of Certified Wood as per International Standard for Phytosanitary Measures (ISPM15 or NIMF15).
- Sealed with screws and secured with plastic bands and two security labels with consecutive numbering or code.
- Every box is stenciled with logos and description of content.
- Interior of crate is protected with kraft paper and bubble wrap for extra protection.
- Every Box is made to size according to customer's order.

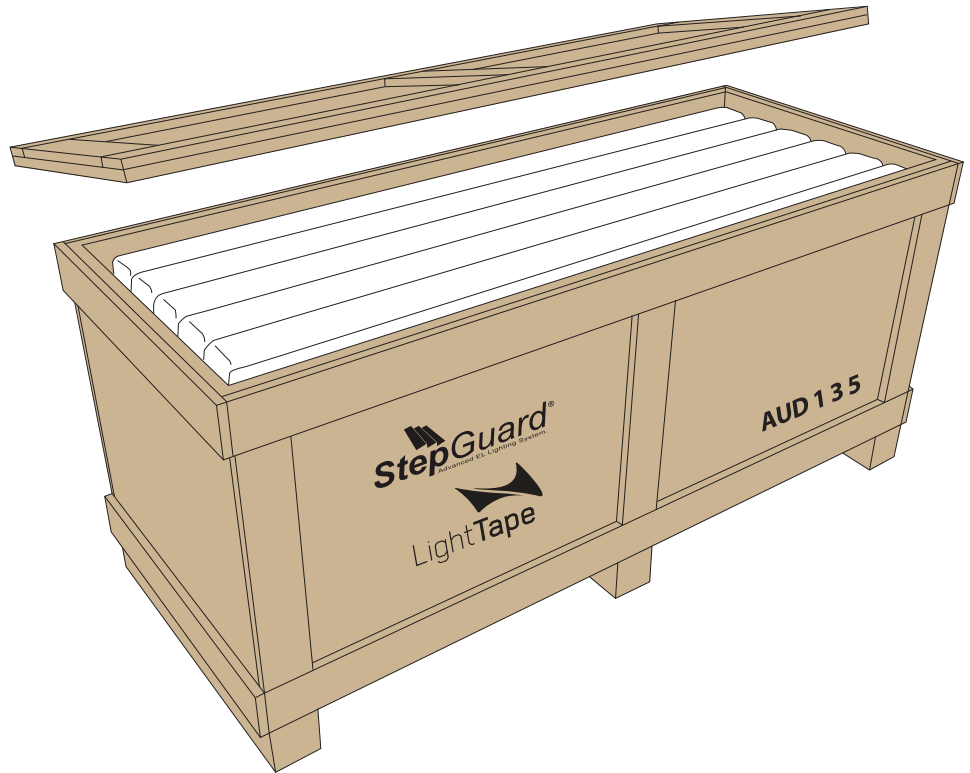

Packing Unit

Units are packed in pairs (as per detail). Box includes also Smart Drivers and spares if requested.

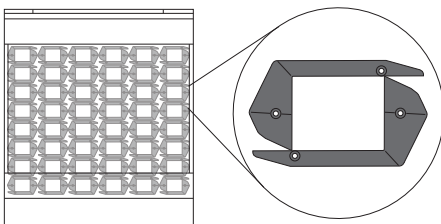

Packing unit
(6 x 10 cms)

Box Dimensions

Height (front view)

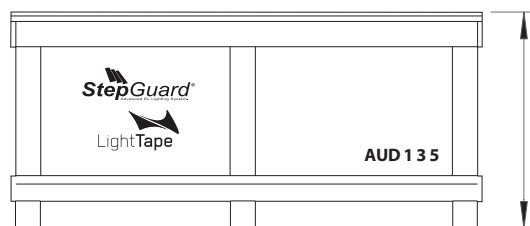

Height of box is calculated by taking the quantity of steps, divided by 12 which is the maximum quantity per row (six pairs). Then adding 6 cms to packing unit and 14cms for the skids and box wall.

Length (top view)

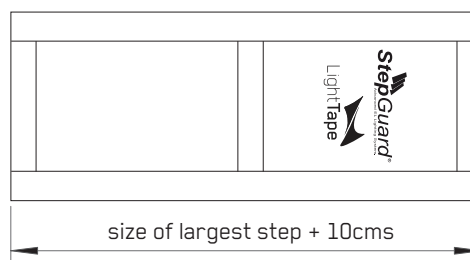

Depth (side view)

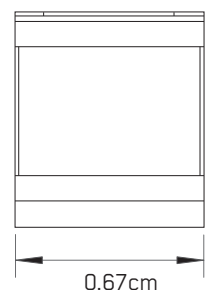

STEPGUARD[®]
INSTALLATION GUIDELINES



Surface and Profile Preparation

1.

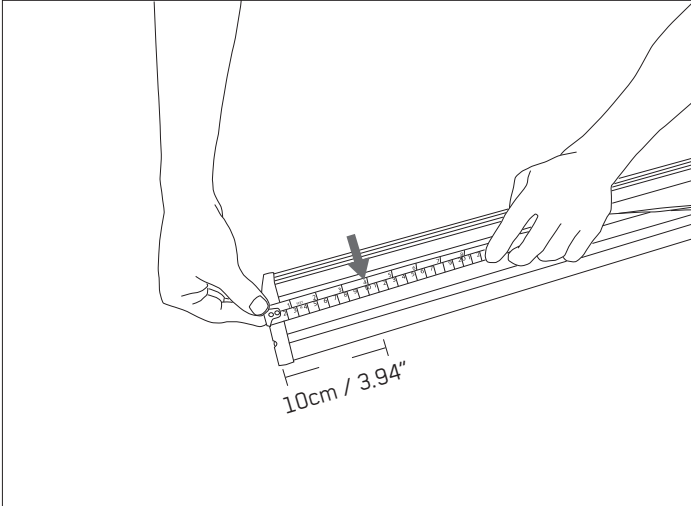

First step is to measure and mark the holes on the profile. We recommend a maximum distance of 10cm on the sides and the other holes should be distributed equally throughout the profile.

IMPORTANT: There should be at least 4 screws per linear meter to ensure a proper fix on surface.

2.

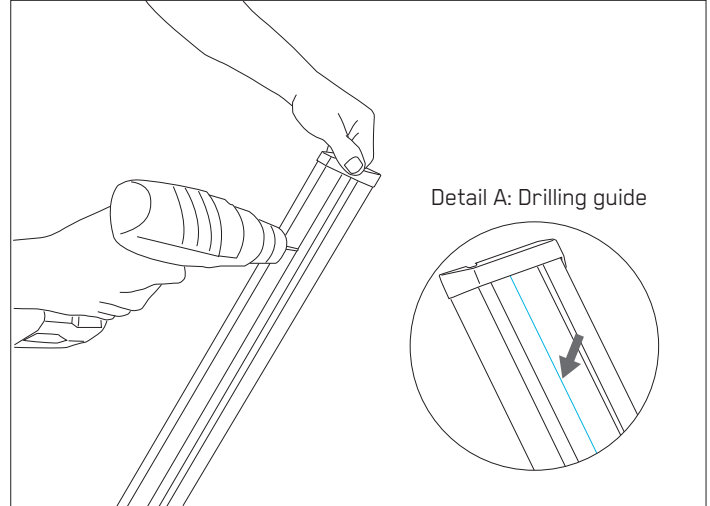

Once you have the marks on the profile, use a metal drill to make the holes. Remember to always use the drilling guide to mark and drill holes as per **Detail A**, because the anti-slip will fit the head of the screws on this area to avoid bumps on it.

3.

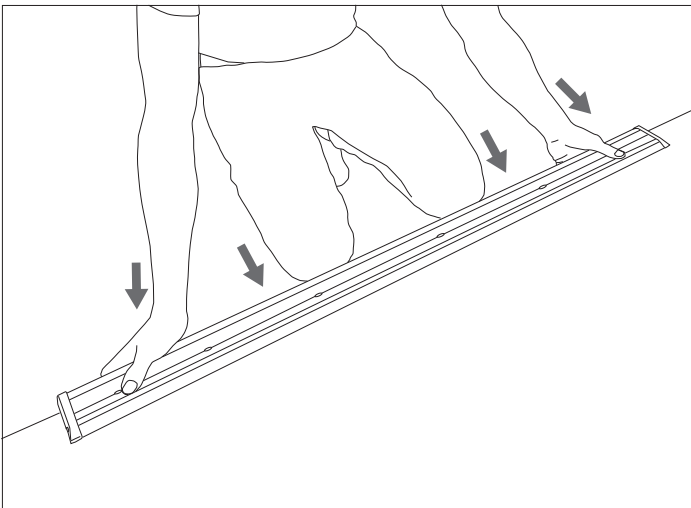

Locate the profile on its position and push it against the stair with both hands and knees to make sure drilling holes are as far possible from corner of step. Make sure profile is secure in its final position.

4.

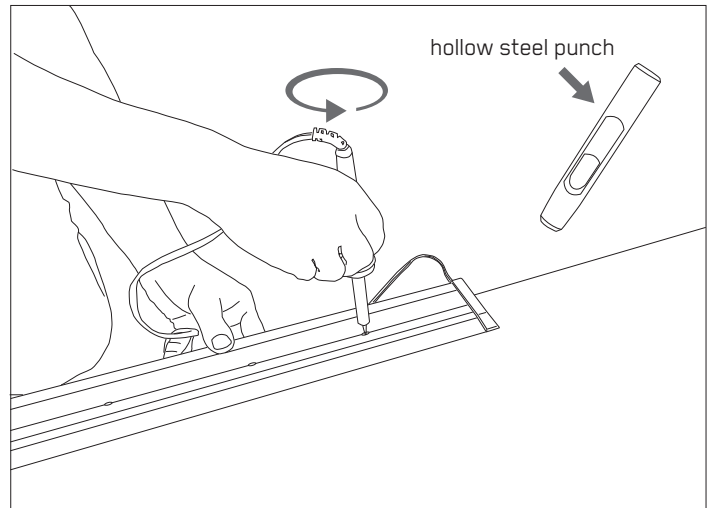

With the help of your knees, keep the profile in its position and burn holes on the carpet with a circular motion on the carpet through the pre-drilled holes of profile. You can also mark the holes on the carpet and use a hollow steel punch or gasket punch (as shown). Now you are ready to drill on concrete without damaging the carpet.

Installing

1.

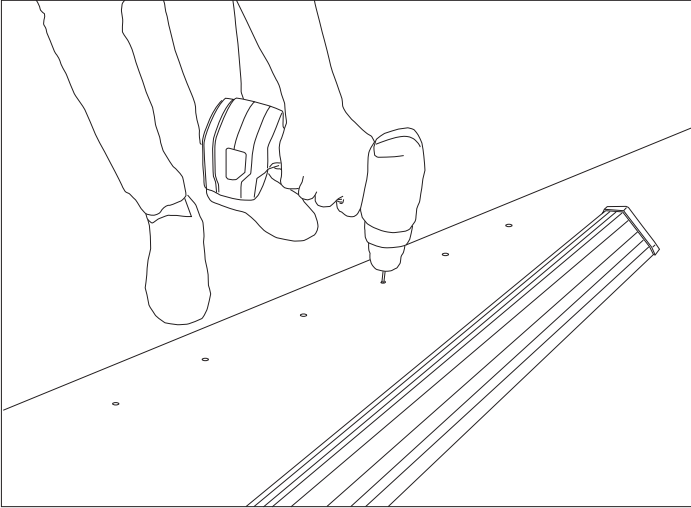

To finalize, drill the holes on concrete or surface and place your screw sledges on place with a hammer. Align profile and screw or hammer on place

2.

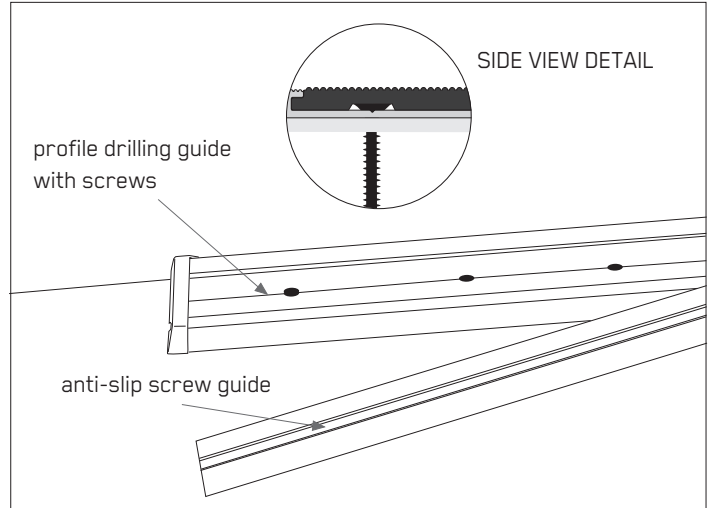

Make sure you place the anti-slip in the correct position matching the screw guide of both parts. No you can begin sliding the anti-slip as explain on next step.

3.

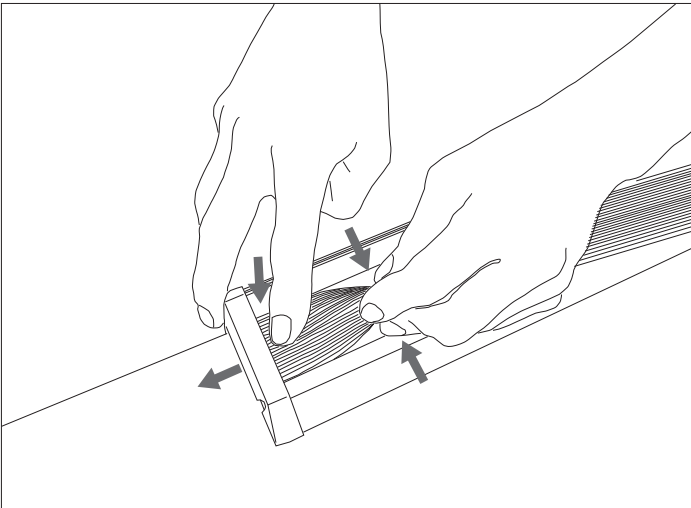

To slide the anti-slip, first push one end underneath the end cap, while pushing the sides. For the rest of the process just push on sides while rubber sits on its position. When finishing on the other side, cut the excess material making sure you leave an extra length (about 1cm-2cm) to fit under the other cap.

4.

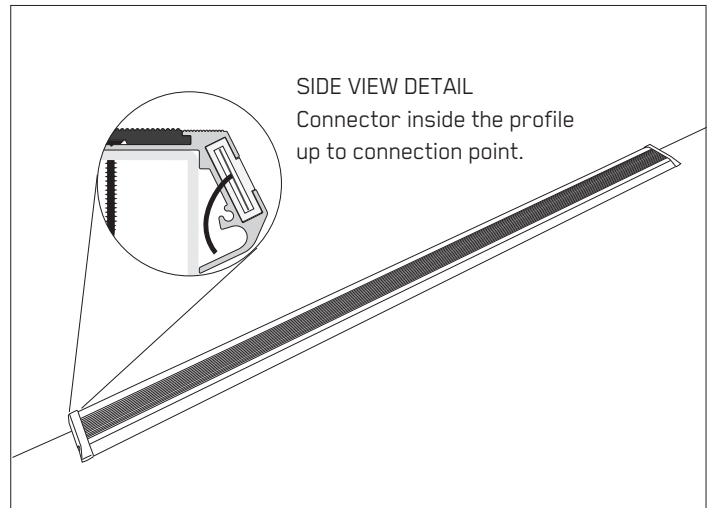

Once unit is installed, do a QC check by stepping on center and sides of the profile, making sure it is fully secured. Also check that connector is hidden inside the profile (see below detail), and there are no loose parts.

Connecting and Wiring

1.

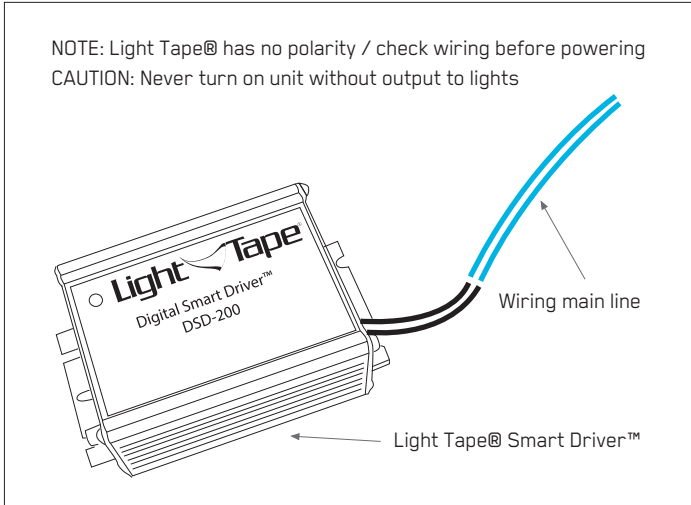

The Digital Smart Driver™ is required to power the Light Tape®. Please make sure you are using the right type of Driver and that is on its illumination range. The driver comes with a dimming button and it should be turned to minimum before powering (if dimming button is included on unit). Once turned on, you can adjust dimmer slowly to desire brightness.

2.

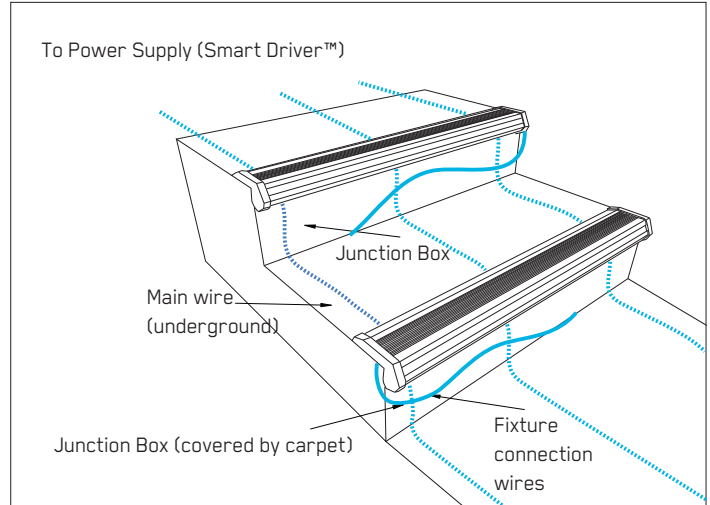

The StepGuard™ step system has been pre-wired to the requested exit side (right or left) when assembling the units at the factory. The main wire, however, can be located through either side or center of the step rows.

3.

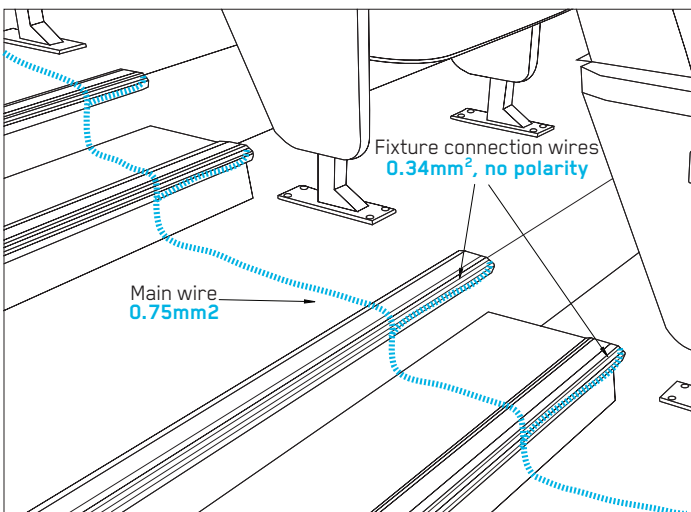

The StepGuard® exit connection wires are supplied with 2x0.34mm² cables. For the main wiring, we recommend using an 0.75mm² cable. Follow all electrical codes when wiring and connecting the system.

4.

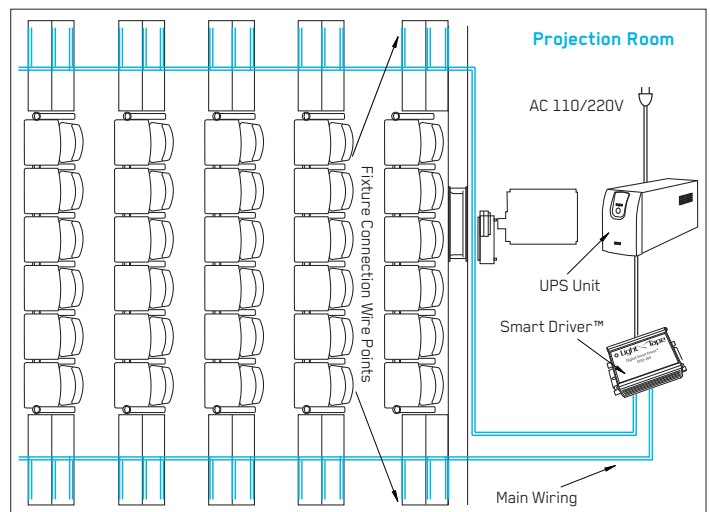

Every step must be properly connected to the main wire following local electrical codes. Please make sure all wire connections are sealed, and there are no loose or pinched wires. For IP65: Dryconn medium waterproof wirenut (#62225) rated for 600V/5A; For standard installation: Ideal 73B orange wire nut rated for 600V/5A; or local equivalent. There is no polarity on Light Tape®.

Type X Connection

The Smart Driver™ Power Supplies, depending on reference, may come with two types of adapters and/or cables to connect to power outlet. In case of damage of cable, this can be easily replaced by user, however the connector or adapter can only be supplied by manufacturer. **To request spares or technical service, please contact: thelighttapeteam@lighttape.com in U.S.A. and rest of the world or : ventas@lighttape.com.co for Colombia and South America.** Please make sure to always include on your request the reference of the Smart Driver™ and/or adapter cable.

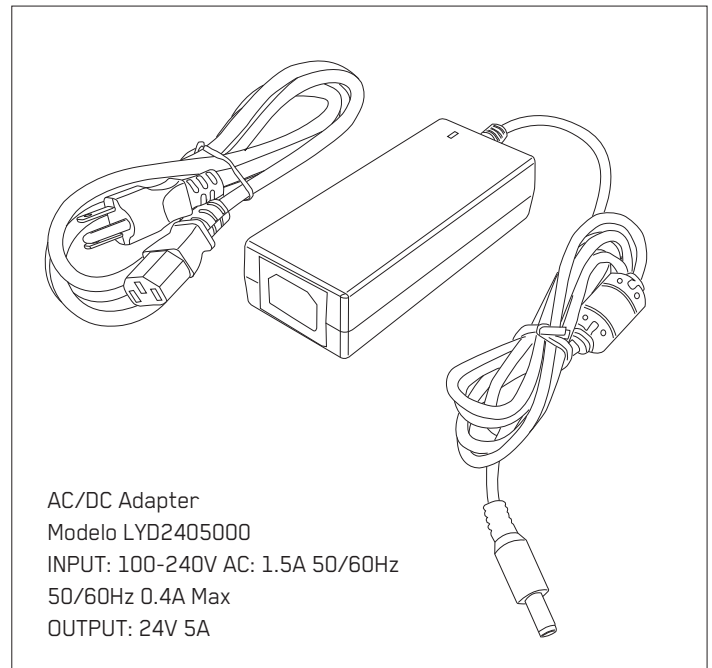
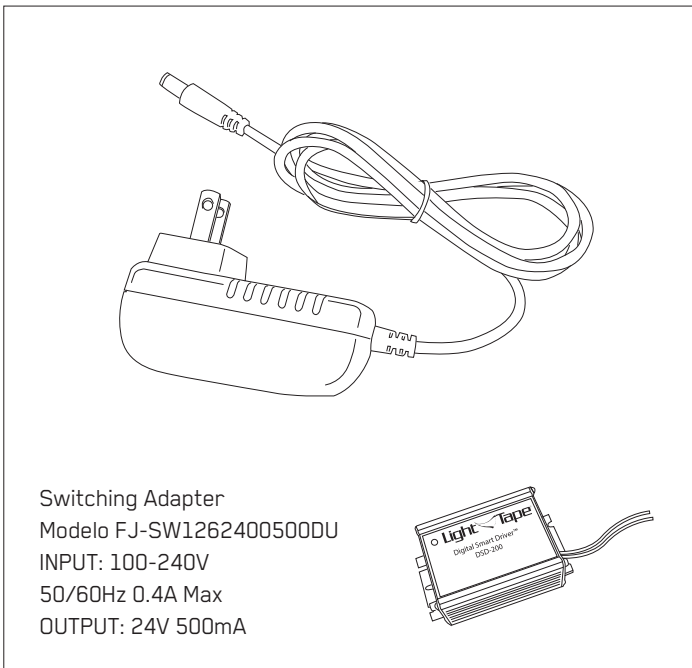

For Type Y Attachments:

If the external flexible cable or cord of this luminaire is damaged, it shall be exclusively replaced by the manufacturer or their service agent or similar qualified person in order to avoid a hazard.

For Non-Replaceable Light Source (Light Tape[®])

The light source of this luminaire is not replaceable. When the light source reaches its end of life, the whole luminaire shall be replaced.

We have a team ready to assist at thelighttapeteam@lighttape.com or +1.804.355.1692



**THIS PRODUCT
CANNOT BE USED ON
INSTALLATIONS OR
FLAMMABLE
SURFACES**



**RISK OF
ELECTRIC SHOCK**

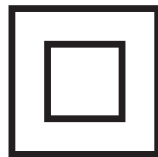

CLASS II



AC CURRENT



INDOOR USE ONLY

**Follow all Electrical Codes
when installing and wiring**

StepGuard Cleaning & Maintenance Information

For external parts of StepGuard™ fixtures

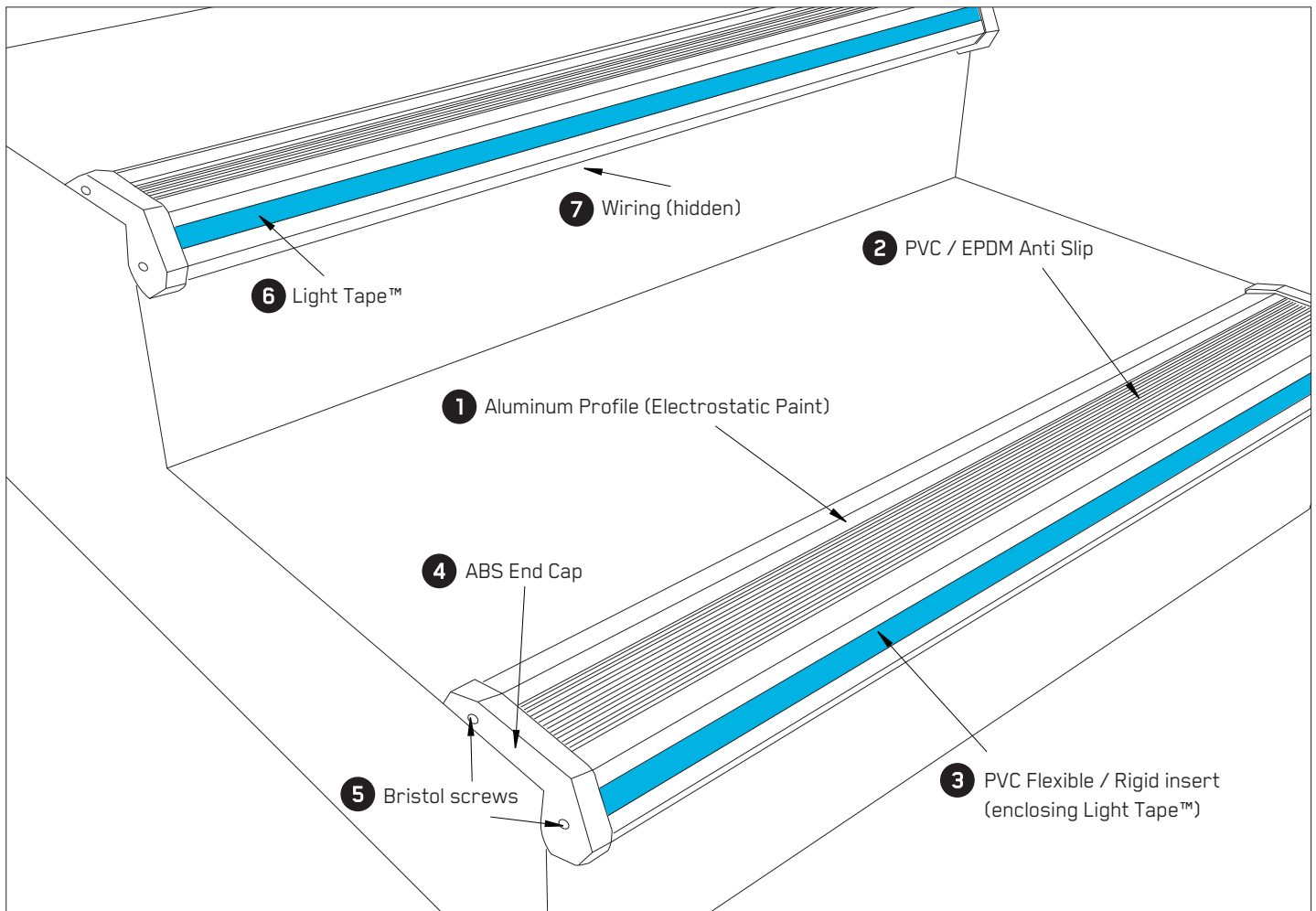

Preventive Maintenance

A visual inspection of the system should be performed regularly. Depending on use but at least once a week the maintenance and/or cleaning personnel should be able to identify that all parts are in place and working properly to run a safe system.

- 1 Aluminum Profiles**
Going down or upstairs will help to make sure all profiles are securely fixed on place. They should not move when stepping on them.
- 2 PVC / EPDM Anti-slip**
Anti-slip should be free of grease and fitted flat on its cavity from end to end.
- 3 PVC Flexible / Rigid insert**
The insert encapsulates the Light Tape™, therefore should be free of cuts or abrasions. No elements should obscure light.

StepGuard Cleaning & Maintenance Information

For external parts of StepGuard™ fixtures

- 4 ABS End Caps**
All end caps must be properly secured to profiles with the screws. Missing, loose or broken end caps should be replaced immediately.
- 5 Bristol Screws (on end caps)**
Both screws should be secured on each end cap. Missing screws or with signs of rust should be replaced immediately
- 6 Light Tape™**
Make sure Light Tape™ lights evenly on its entire length. Lights should not twinkle or blink while on. Light Tape™ should be replaced if signs of humidity, or stains are shown. Please contact Technical Department for more information.
- 7 Wiring**
Inspect that no wires are hanging below fixture. All wiring should be hidden and secure underneath the extrusion.

General Cleaning

A regular cleaning should be performed to prevent the build up of dirt and grease, which could compromise the anti-slip properties and the general appearance of the fixture.

Avoid the use of cleaners containing hydrocarbons, bleach or citrus based agents to clean the StepGuard™ fixtures. You should also avoid the use of steam cleaners, power washers or floor sealants to clean the inserts or end caps.

FOR DAILY CLEANING

Brush down the entire fixture using a soft bristled brush and clean the insert and anti-slip using a damp cloth. Do not soak around the caps or connection or wiring areas.

Aluminum profiles

If heavier marks or sticky stains are seen, clean them using a damp cloth with aluminium safe detergent. Light surface scratches on paint can be removed using a fine wire wool and buffed with a soft cloth. Make sure as much water or cleaning solution is removed as possible.

ABS End Caps / PVC Clear inserts

Only soap and water should be used during ABS cleaning as the use of other chemicals such as chlorides, ketones and degreasers accelerates aging and give them a yellowish color. The cleaning should be done with with a soft cloth or paper. Allow the system to be completely dry.

If you have any doubts or questions regarding product maintenance, please contact our Technical Department at:

Electro-LuminX Lighting Corporation

1320 North Arthur Ashe Boulevard	1.804.355.1692
Richmond, Virginia 23230	+44.7860.967410 GMT
	thelighttapeteam@lighttape.com



StepGuard[®]
Advanced EL Lighting System.



designed for
LightTape[®]

Electro-Luminix Lighting Corporation

1320 North Arthur Ashe Boulevard
Richmond, Virginia 23230

1.804.355.1692
thelighttapeteam@lighttape.com